

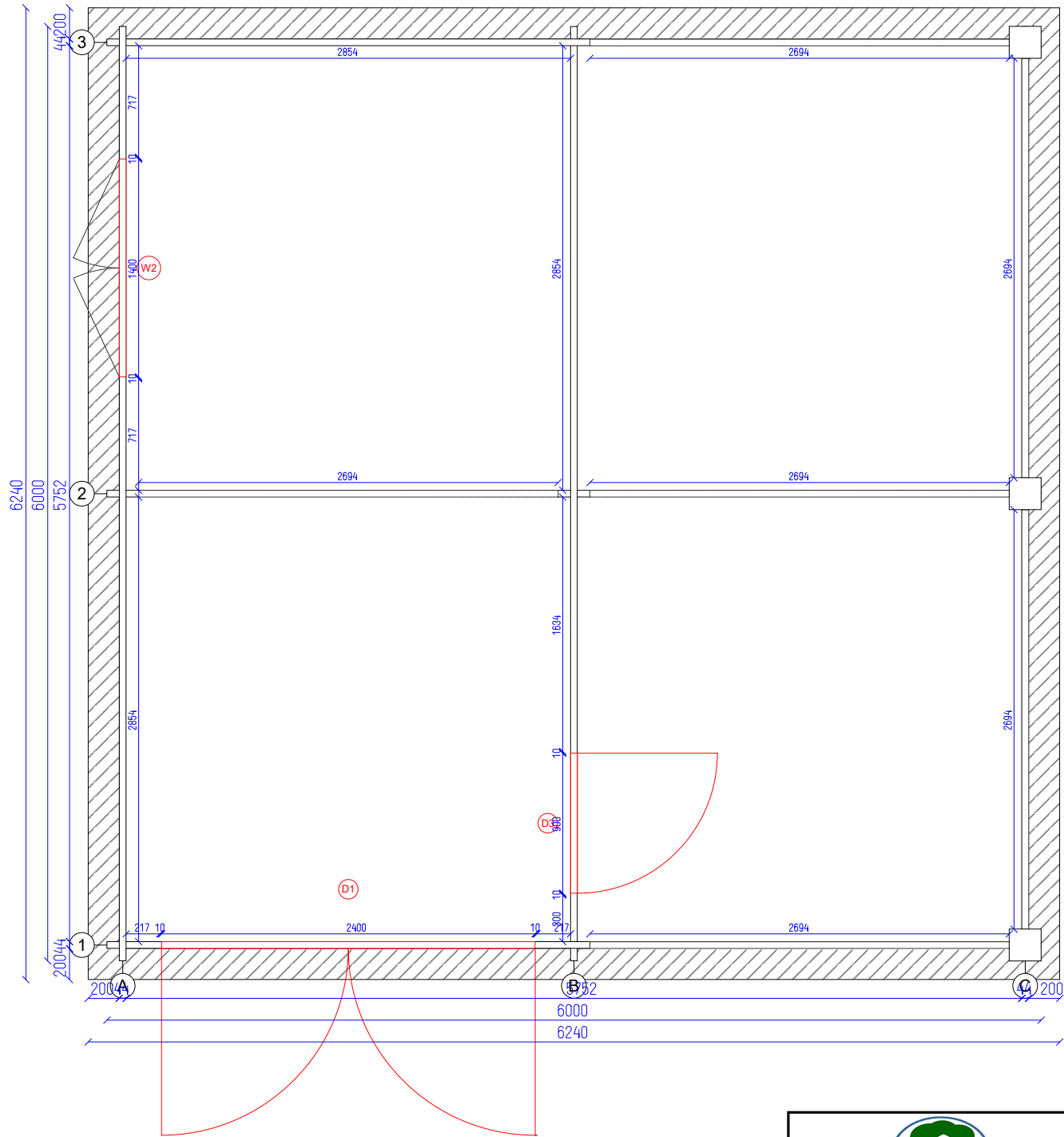

Carport with Garage 44



Carport with Garage 44

Ground plan

Tikr.

Dare
AND

2
SHEET

9
OF

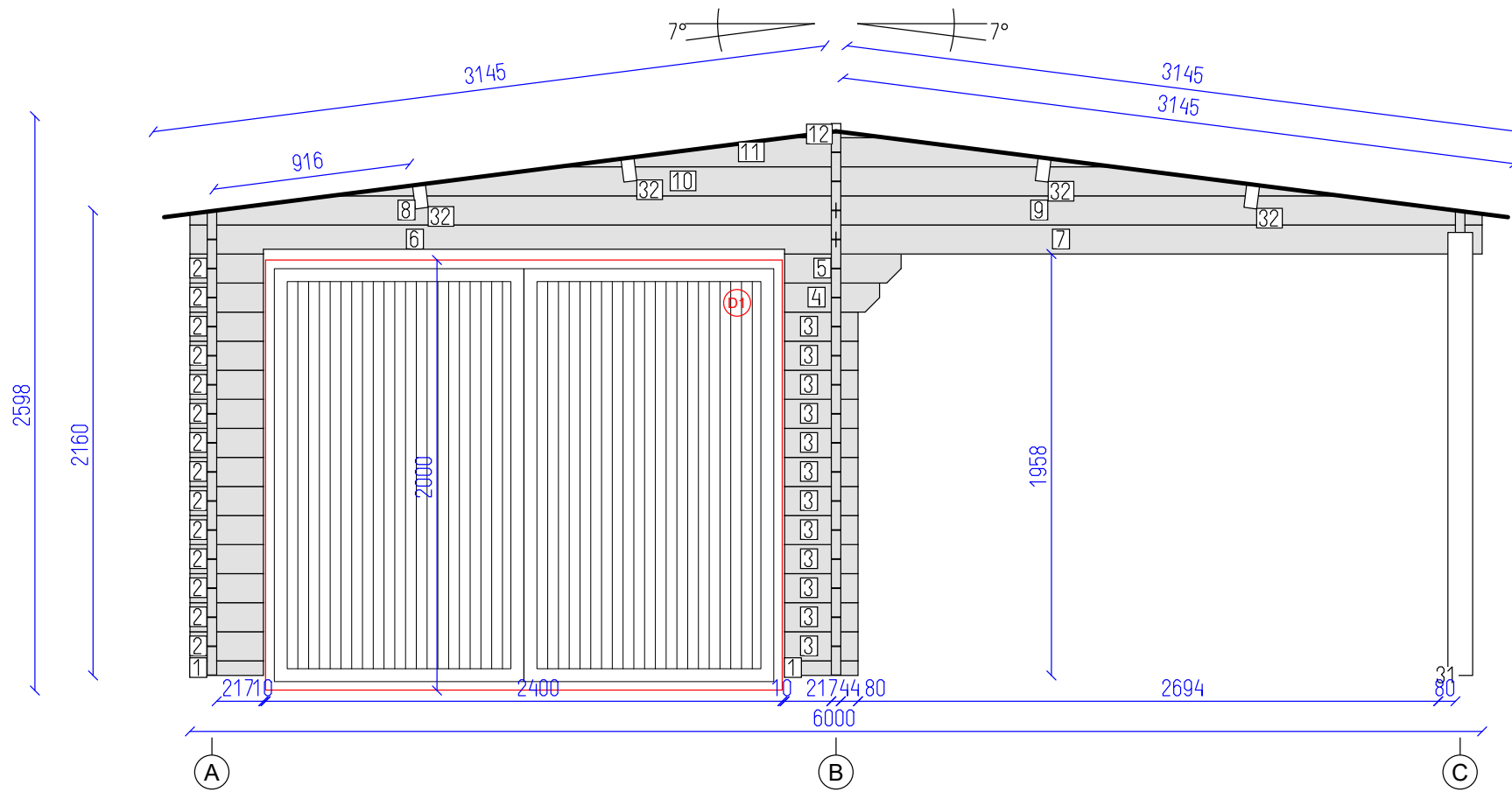

DETAILS

N	QTY
1	2
2	14
3	12
4	1
5	1
6	1
7	1
8	1
9	1
10	1
11	1
12	1
31	1
32	4

LIST OF ELEMENTS

1. Wall 68x44x341
 2. Wall 135x44x341
 3. Wall 135x44x341
 4. Wall 135x44x441
 5. Wall 135x44x541
 6. Wall 135x44x3000
 7. Wall 135x44x3000
 8. Wall 135x44x3000
 9. Wall 135x44x3000
 10. Wall 135x44x4694
 11. Wall 135x44x2584
 12. Wall 30x44x474
 31. Post 115x115x2058
 32. Roof beam 140x70x3398
- Total 6.13 m²

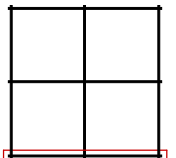

Carport with Garage 44



Wall 1

Tikr. ---

Dare AND

3

9

SHEET

OF

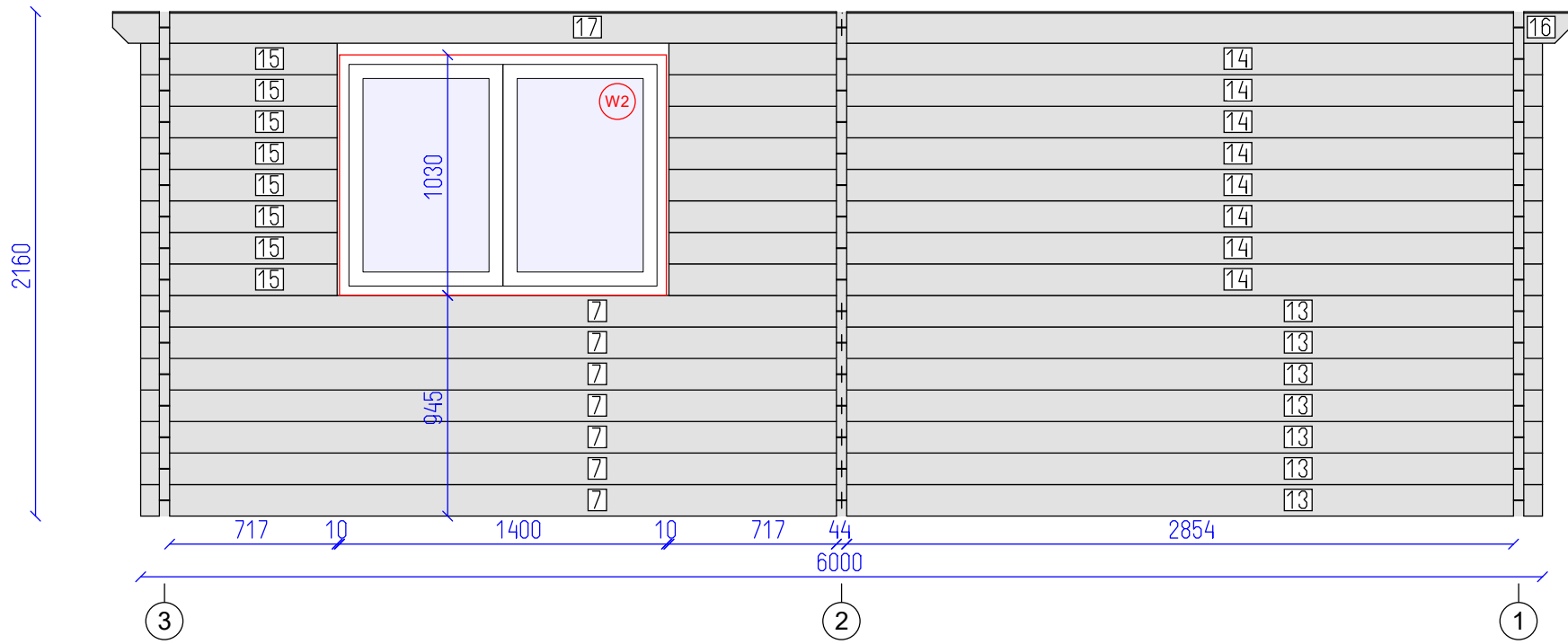

DETAILS

N	QTY
13	7
7	7
14	8
15	8
16	1
17	1

- LIST OF ELEMENTS
- 13. Wall 135x44x3000
 - 7. Wall 135x44x3000
 - 14. Wall 135x44x3739
 - 15. Wall 135x44x841
 - 16. Wall 135x44x3120
 - 17. Wall 135x44x3120
- Total 11.46 m²

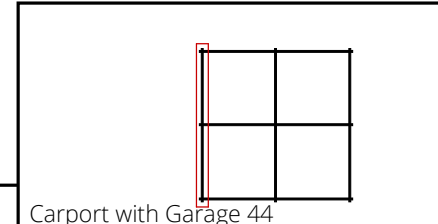

Carport with Garage 44

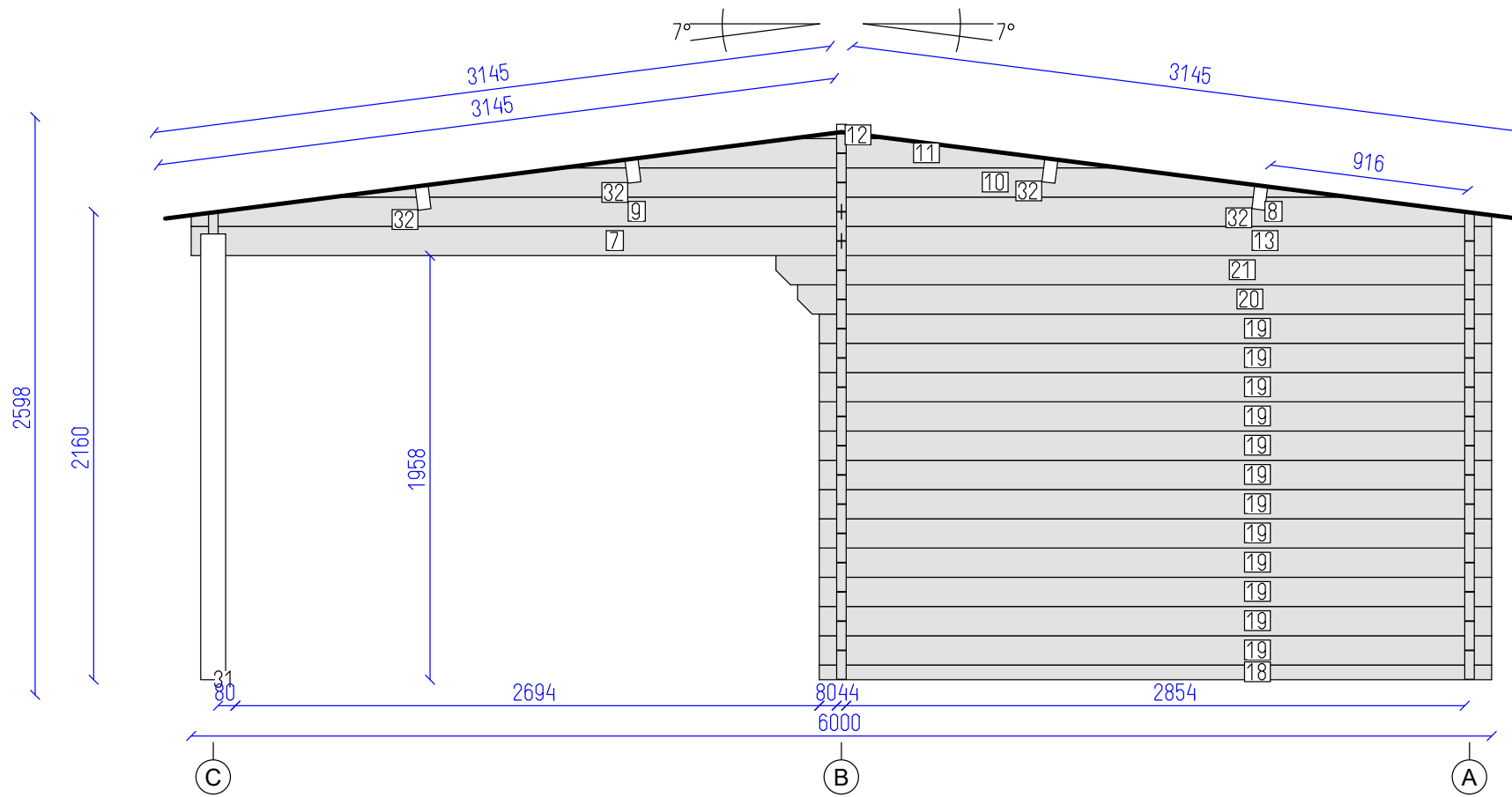

DETAILS

N	QTY
18	1
19	12
20	1
21	1
13	1
7	1
8	1
9	1
10	1
11	1
12	1
31	1
32	4

LIST OF ELEMENTS

- 18. Wall 68x44x3102
 - 19. Wall 135x44x3102
 - 20. Wall 135x44x3202
 - 21. Wall 135x44x3302
 - 13. Wall 135x44x3000
 - 7. Wall 135x44x3000
 - 8. Wall 135x44x3000
 - 9. Wall 135x44x3000
 - 10. Wall 135x44x4694
 - 11. Wall 135x44x2584
 - 12. Wall 30x44x474
 - 31. Post 115x115x2058
 - 32. Roof beam 140x70x3398
- Total 10.87 m²

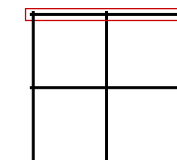

Carport with Garage 44



Wall 3

Tikr. ---

Dare AND

5 SHEET

9 OF

DETAILS

N	QTY
22	1
23	1
31	3

LIST OF ELEMENTS

22. Wall 135x44x3120
 23. Wall 135x44x3120
 31. Post 115x115x2058
 Total 1.55 m²

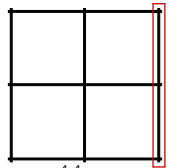
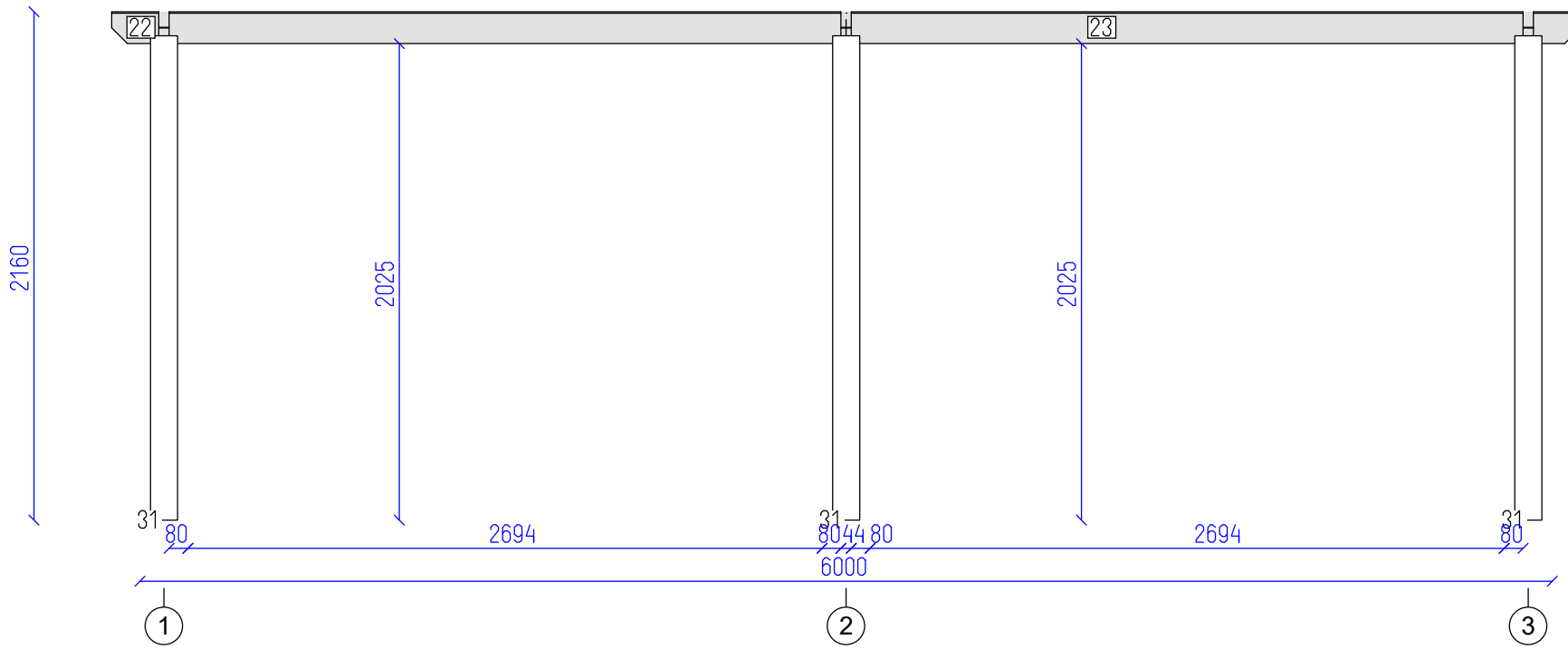

Carport with Garage 44



Wall C

Tikr. ---

Dare AND

6 SHEET

9 OF

DETAILS

N	QTY
24	15
25	15
13	3
7	3
26	2

LIST OF ELEMENTS

- 24. Wall 135x44x424
 - 25. Wall 135x44x4656
 - 13. Wall 135x44x3000
 - 7. Wall 135x44x3000
 - 26. Wall 98x44x3120
- Total 13.33 m²

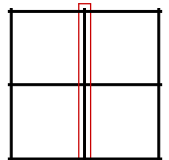
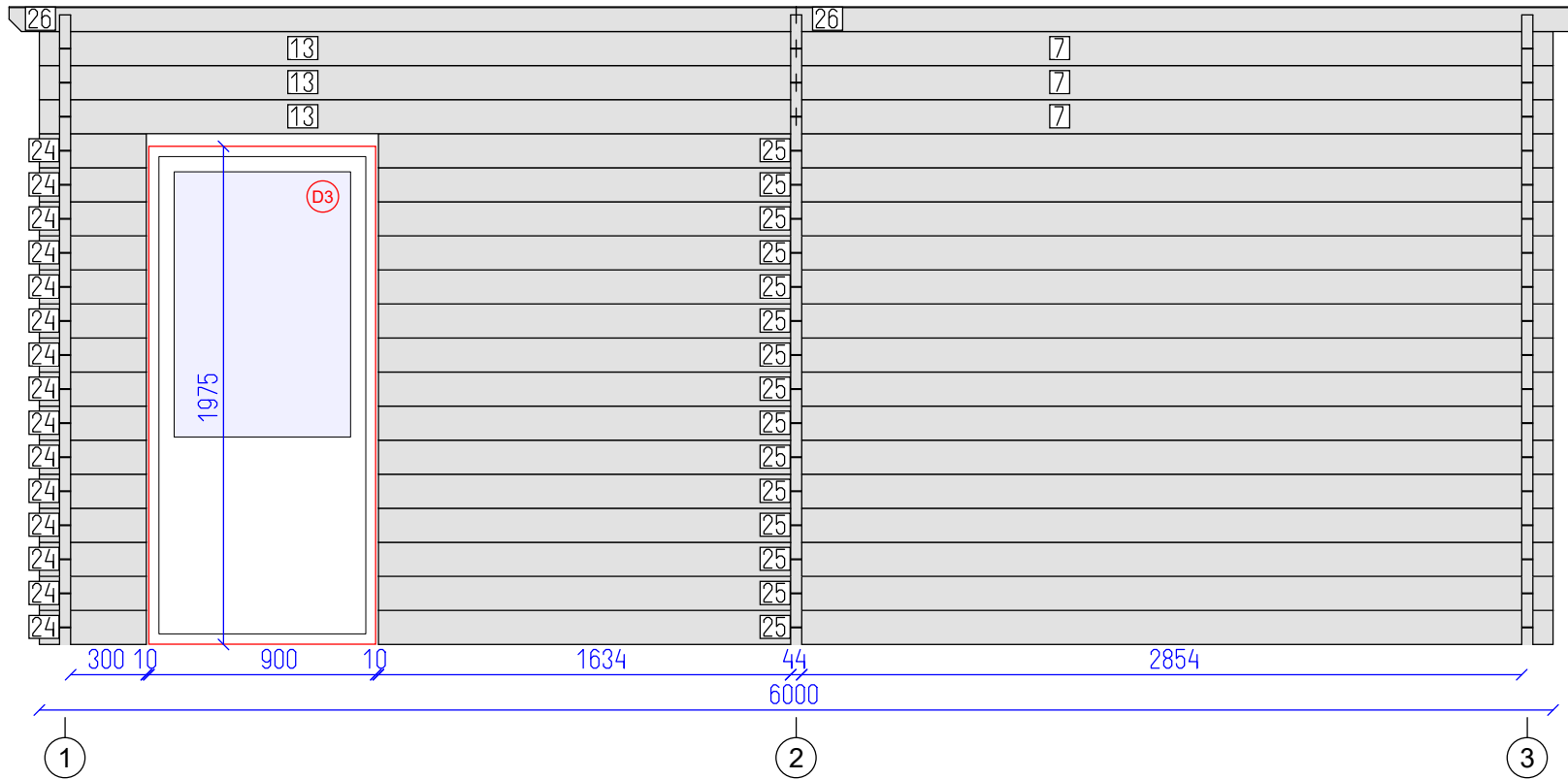

Carport with Garage 44



DETAILS

N	QTY
27	2
28	26
29	1
30	1
13	1
7	1
8	1
9	1
10	1
11	1
12	1
31	1
32	4

LIST OF ELEMENTS

- 27. Wall 68x44x204
 - 28. Wall 135x44x204
 - 29. Wall 135x44x304
 - 30. Wall 135x44x404
 - 13. Wall 135x44x3000
 - 7. Wall 135x44x3000
 - 8. Wall 135x44x3000
 - 9. Wall 135x44x3000
 - 10. Wall 135x44x4694
 - 11. Wall 135x44x2584
 - 12. Wall 30x44x474
 - 31. Post 115x115x2058
 - 32. Roof beam 140x70x3398
- Total 5.60 m²

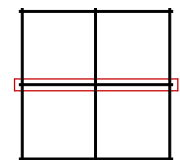
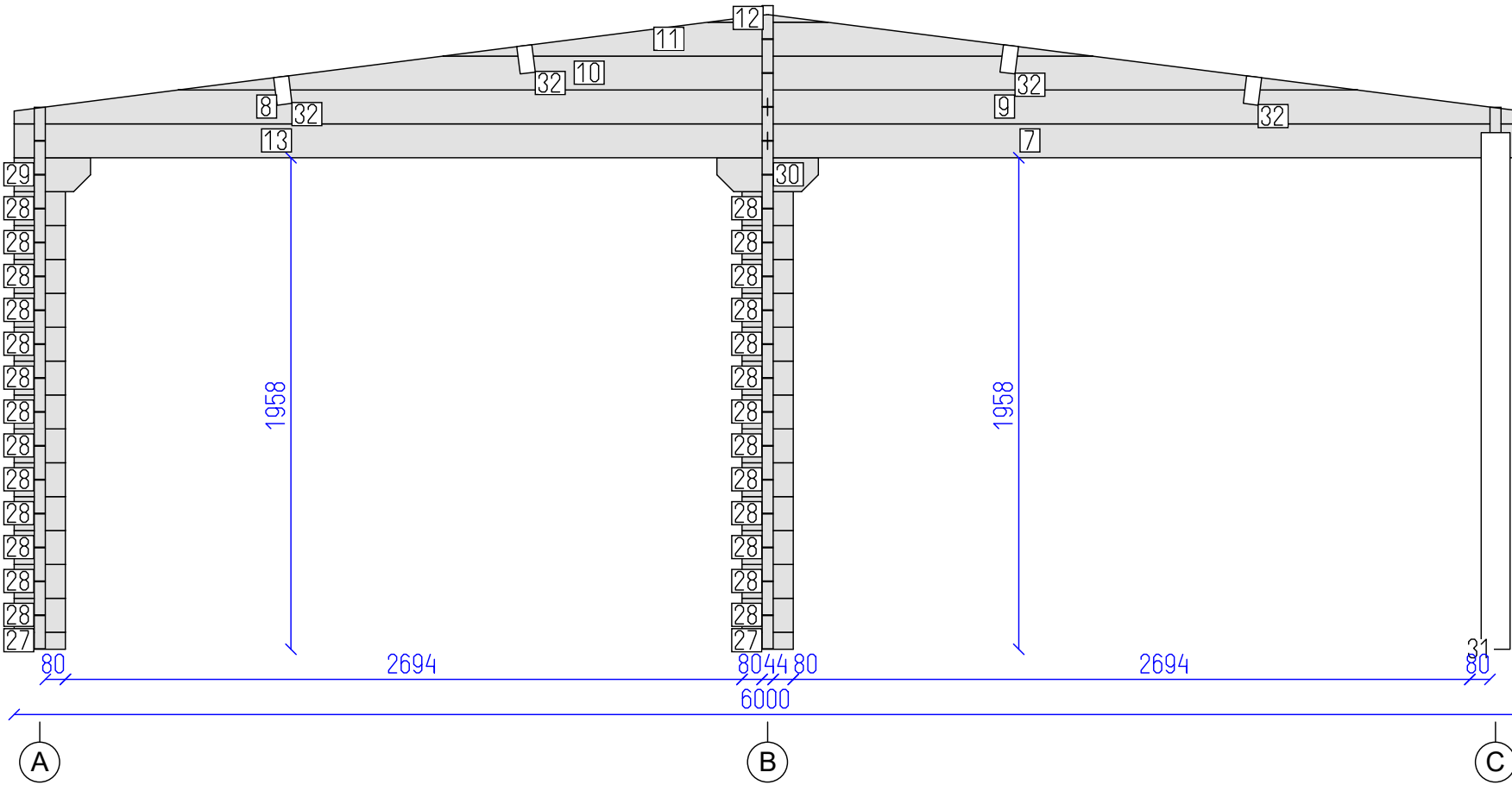

Carport with Garage 44



Wall 2

Tikr. ---

Dare AND

8 OF

9 OF

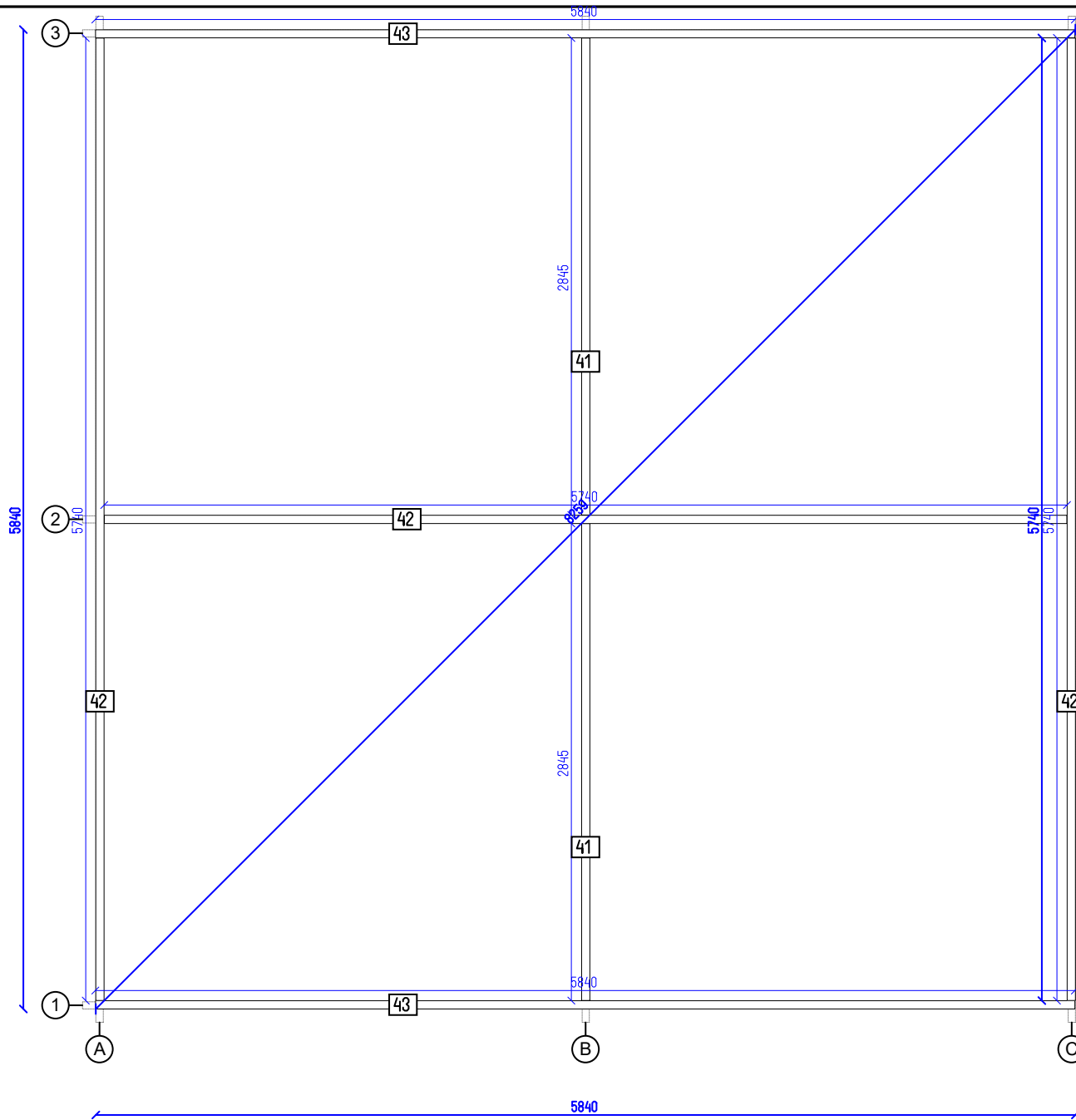

Carport with Garage 44

Flr. bearers pl. ---

Tikr. ---

Dare AND

9 SHEET

9 OF