

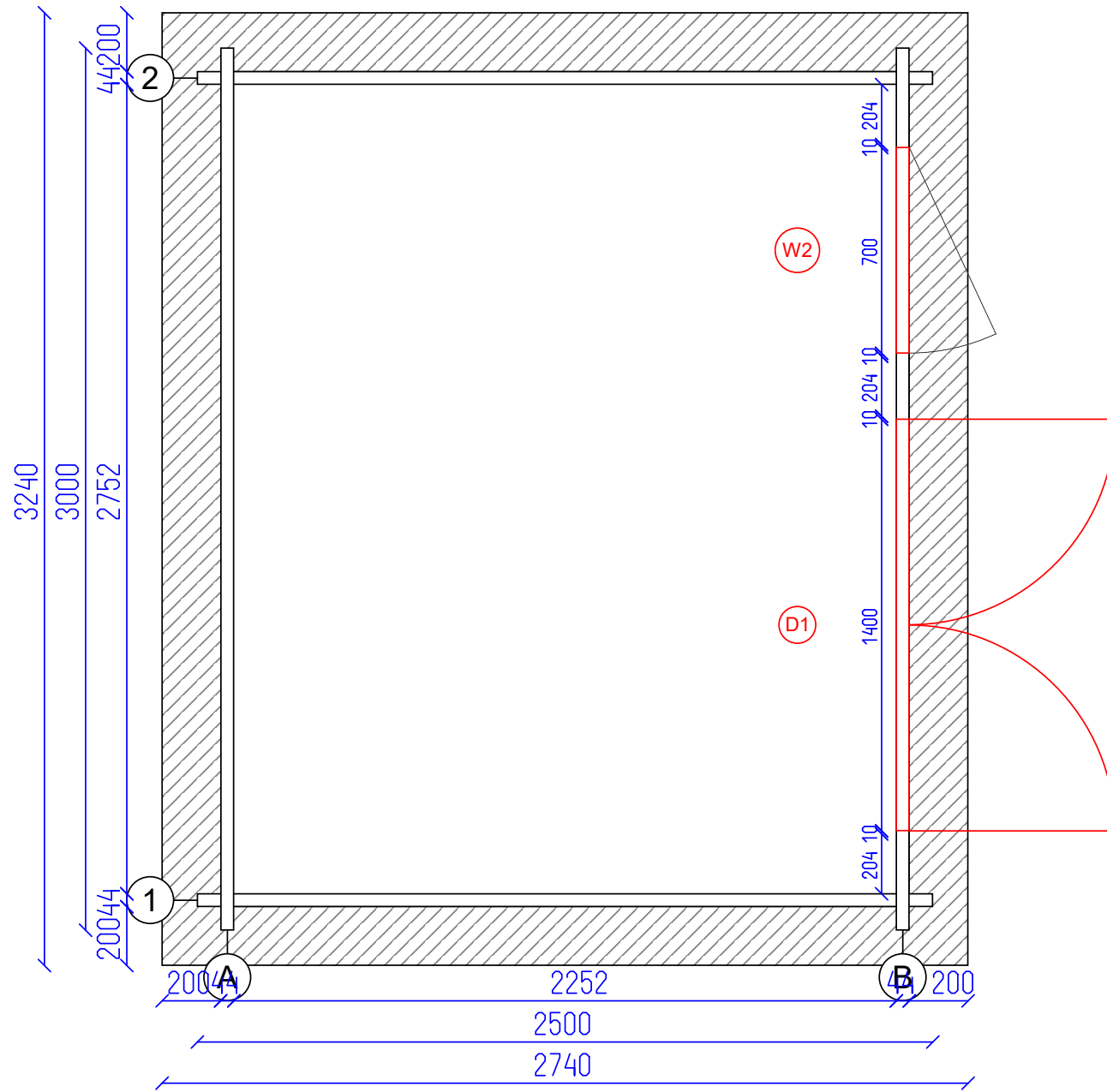

Andalo 44



Andalo 44

Ground plan

Tikr.

Dare
AND

2
SHEET

7
OF

DETAILS

N	QTY
1	1
2	15
3	1
4	1
12	1
13	2

LIST OF ELEMENTS

1. Wall 68x44x2500
 2. Wall 135x44x2500
 3. Wall 135x44x2500
 4. Wall 135x44x1666
 12. Roof beam 140x44x3240
 13. Roof beam 140x44x3240
- Total 7.16 m²

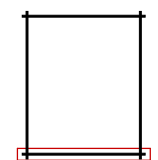
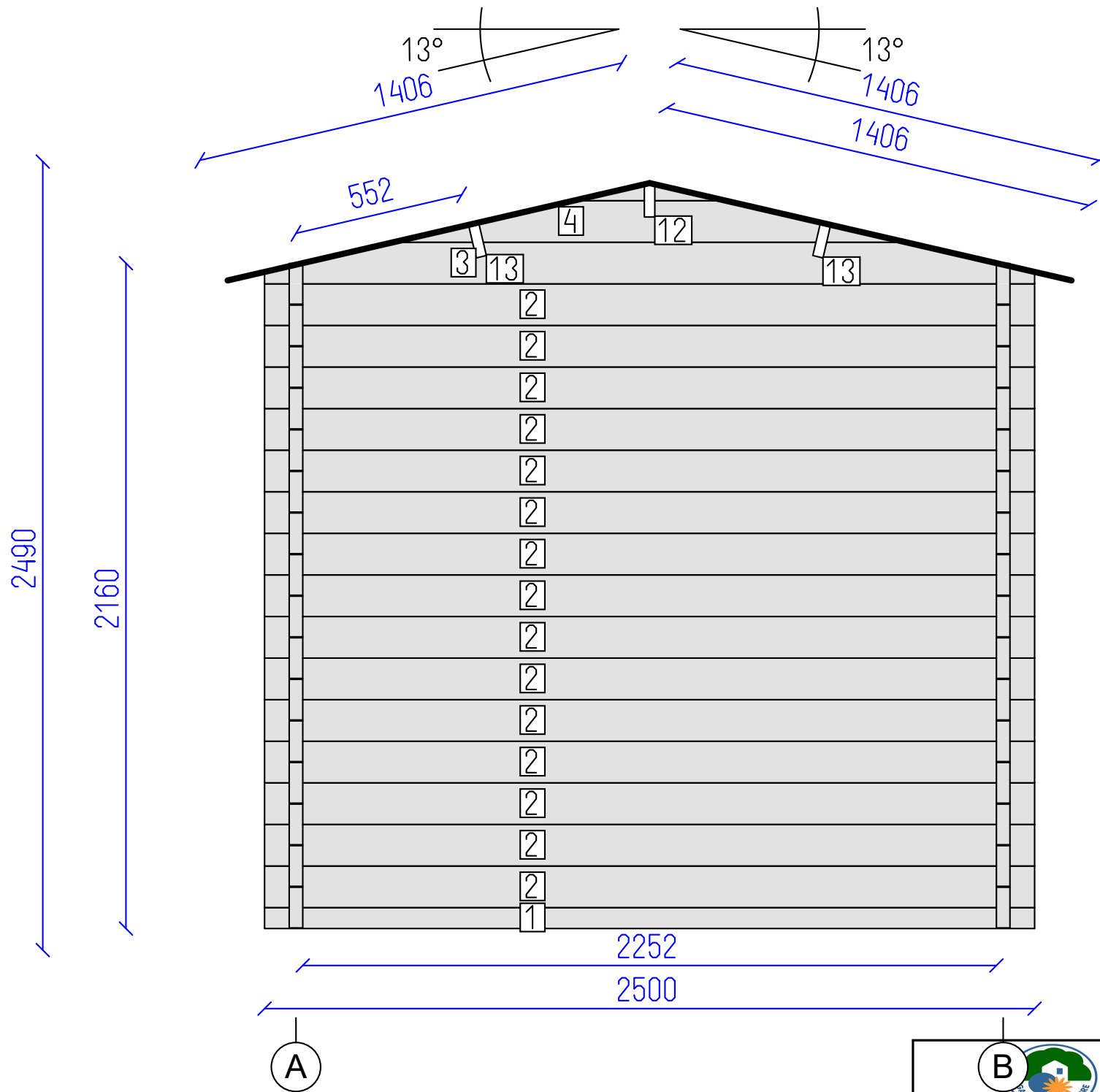

Andalo 44

Wall 1



Tikr. ---

Dare AND

3 SHEET

7 OF

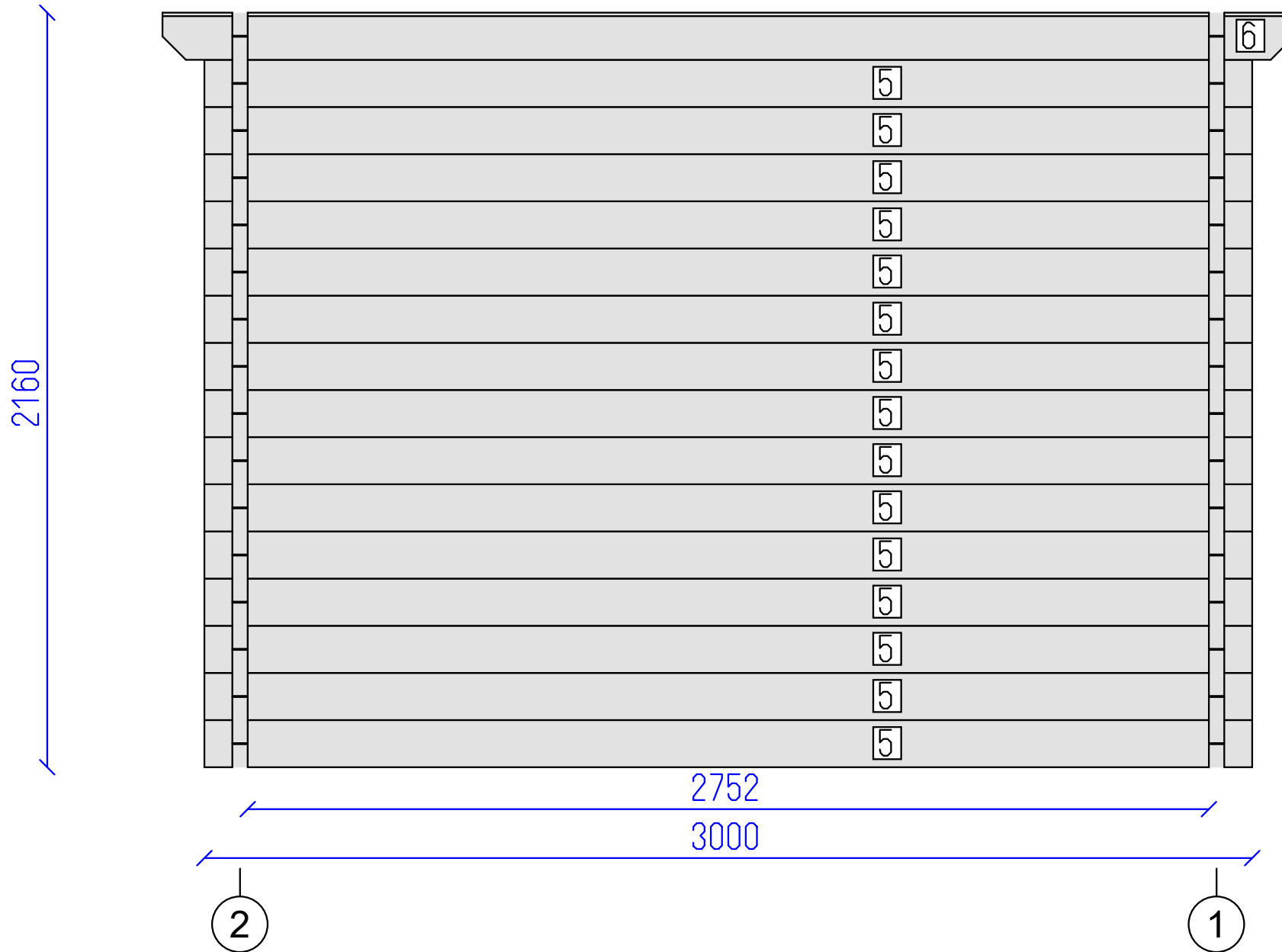

DETAILS

N	QTY
5	15
6	1

LIST OF ELEMENTS

5. Wall 135x44x3000
 6. Wall 135x44x3240
 Total 6.51 m²

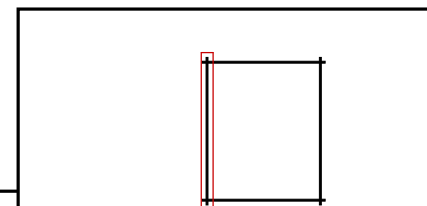

Andalo 44

Wall A

Tikr.

Dare
AND

4
SHEET

7
OF

DETAILS

N	QTY
1	1
2	15
3	1
4	1
12	1
13	2

LIST OF ELEMENTS

1. Wall 68x44x2500
 2. Wall 135x44x2500
 3. Wall 135x44x2500
 4. Wall 135x44x1666
 12. Roof beam 140x44x3240
 13. Roof beam 140x44x3240
- Total 7.16 m²

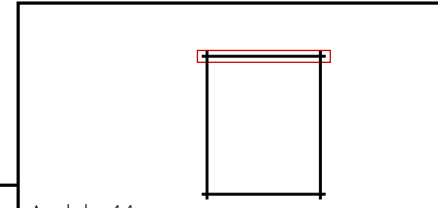
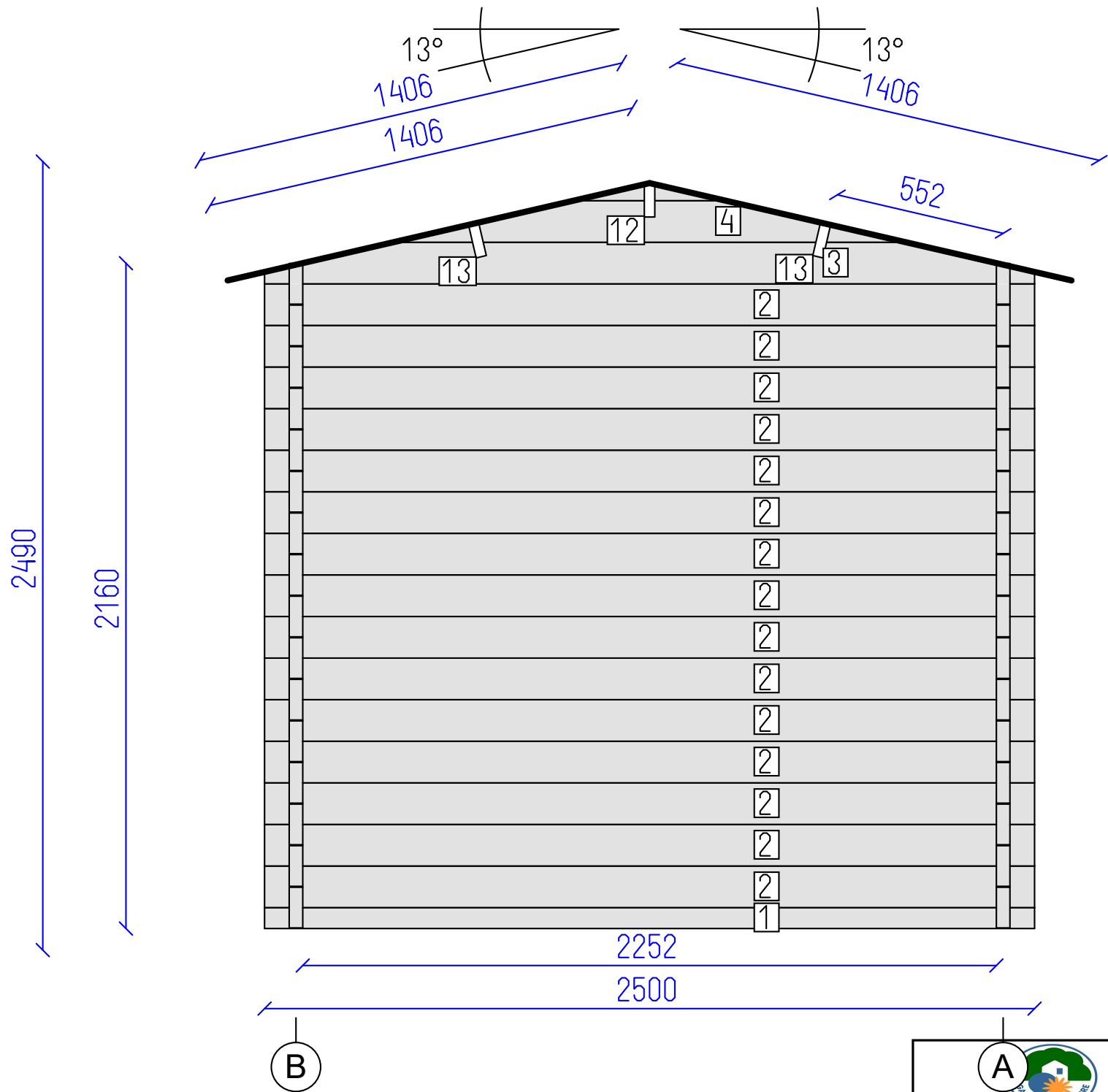

Andalo 44

Wall 2

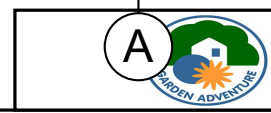

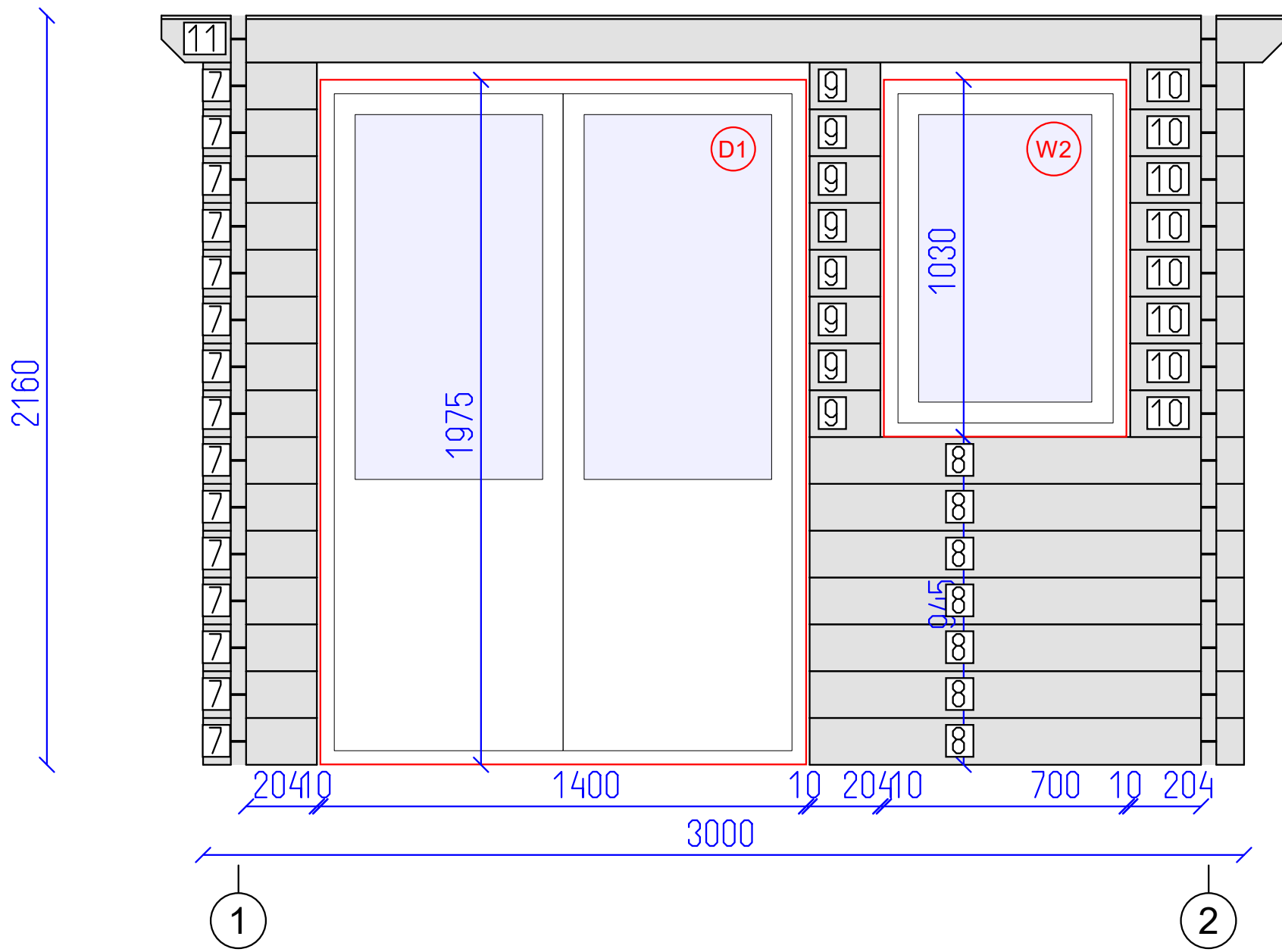

DETAILS

N	QTY
7	15
8	7
9	8
10	8
11	1

LIST OF ELEMENTS

- 7. Wall 135x44x328
 - 8. Wall 135x44x1252
 - 9. Wall 135x44x204
 - 10. Wall 135x44x328
 - 11. Wall 135x44x3240
- Total 2.86 m²



Andalo 44

Wall B	Tikr. ---	Dare AND	6 SHEET	7 OF
--------	-----------	----------	---------	------

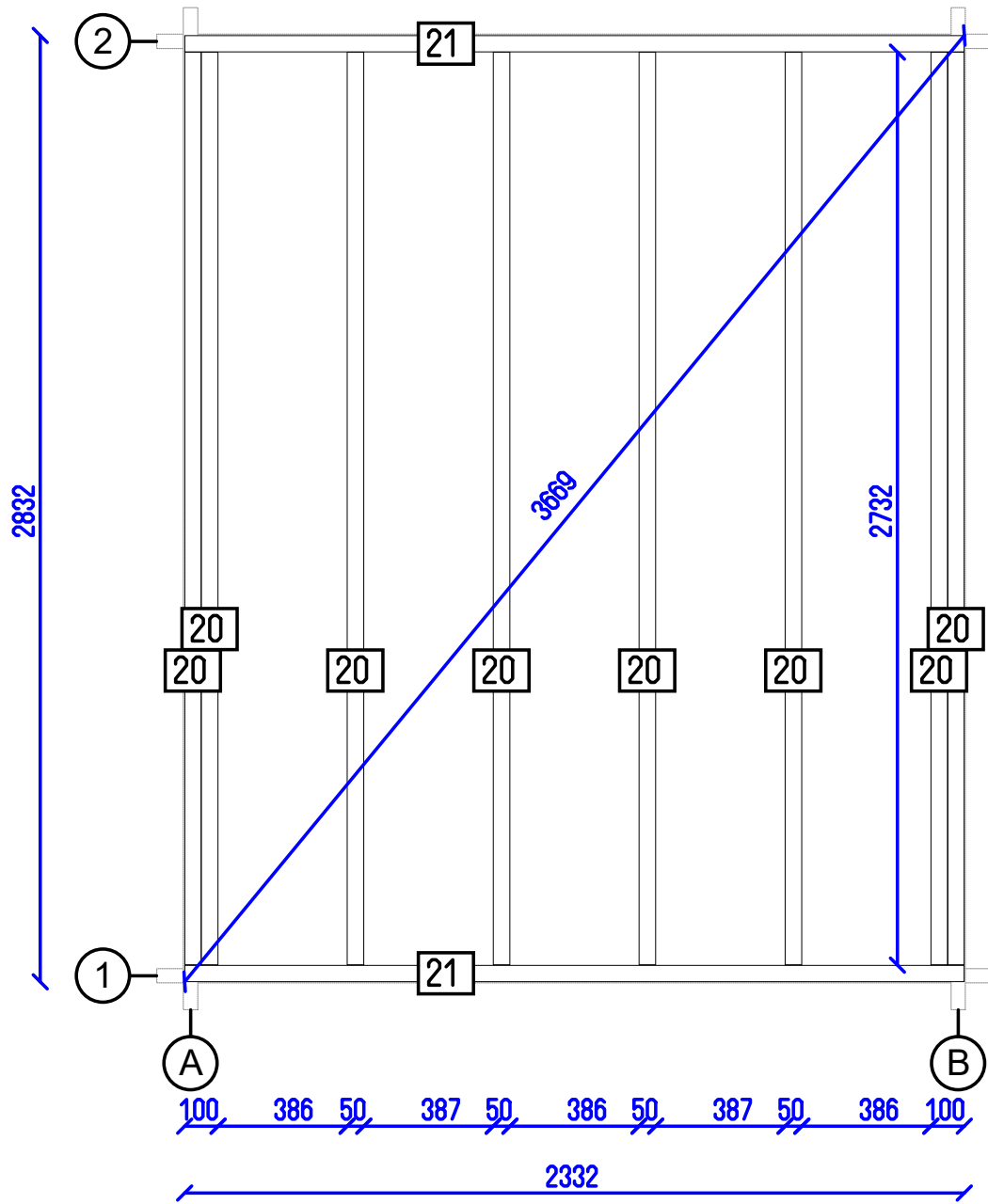

Andalo 44

Flr. bearers pl.

Tikr. ---

Dare AND

7 OF SHEET

7 OF